

H	
4.3	4.5
5.0	5.5
6.0	6.5
7.0	7.5
8.0	8.5
9.0	9.5

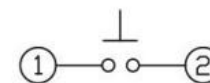

电路图

主要技术规格:

1. 额定值: 50mA DC12V
2. 接触电阻: $\leq 50m\Omega$
3. 操作力: $160\pm 40gf$ & $250\pm 40gf$
4. 行程: $0.3\pm 0.1mm$
5. 绝缘电阻: $\geq 100M\Omega$
6. 抗电强度: 250V 50HZ 1Min.
7. 寿命: 100,000 Cycles
8. 防水等级: IP67
9. 防银迁移: 60V, 85°C, 90%RH/60H

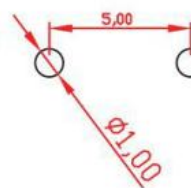
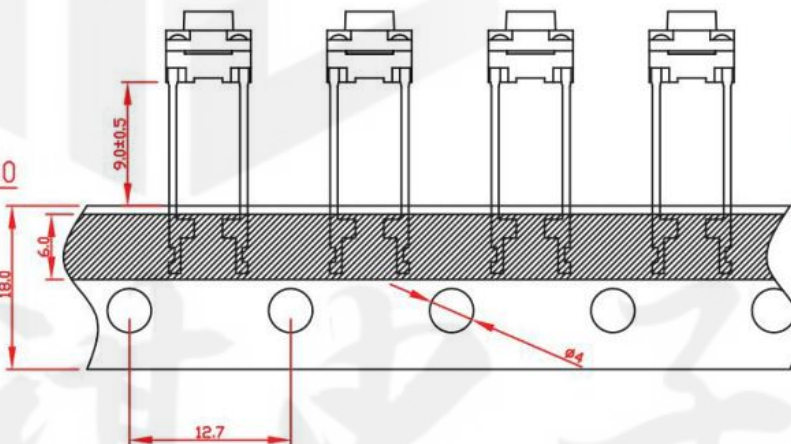
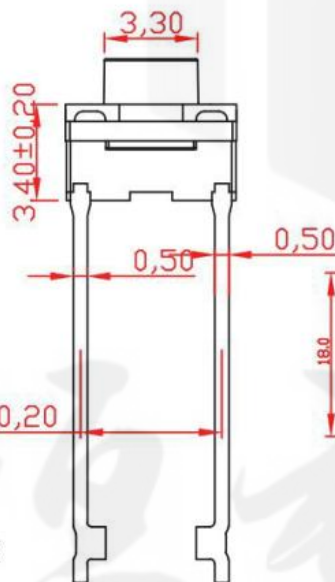

PCB. 焊接图

设计:	Arvin: 2016.03.08	范围 Range	公差 Tolerance
审核:	Arvin:	X.X ±	X.X ±0.30
校对:	Ru yi:	X.XX ±	X.XX ±0.20
比例:	视角关系:	X.XXX ±	X.XXX ±0.10
版次:	图框大小: A4	Angle ±	Angle ±5°

东莞市恒祺电子科技有限公司

名称: 防水轻触开关 | 型号: TH-G003

料号:

共 张 , 第 张

备注: