

RoHS
COMPLIANT

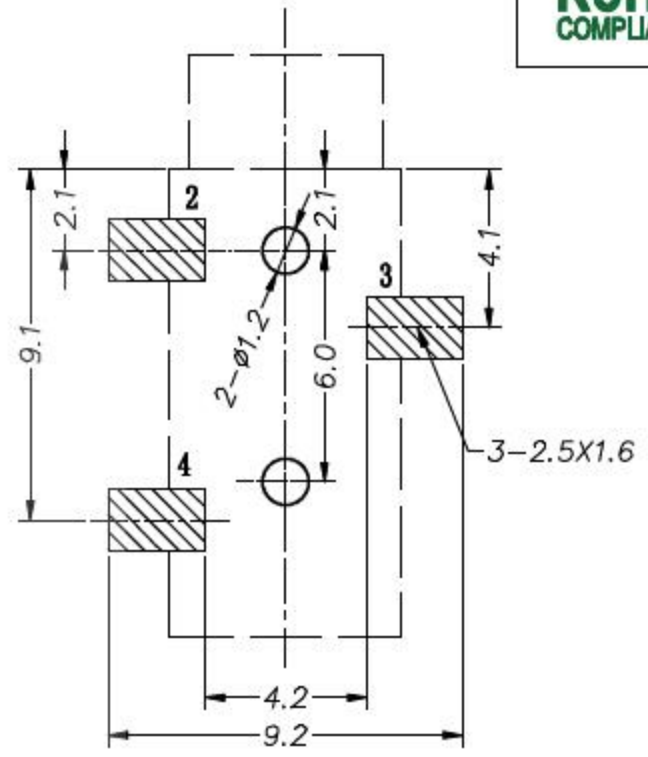

P. C. B LAYOUT TOP VIEW

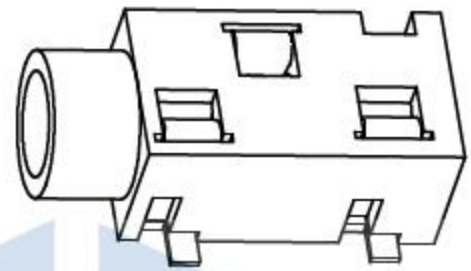
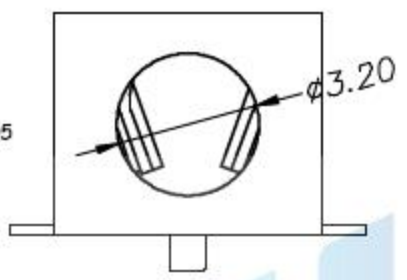
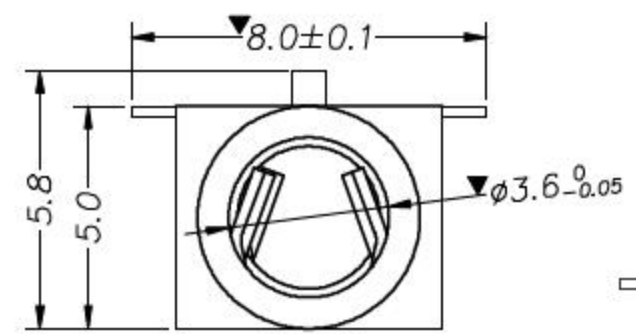
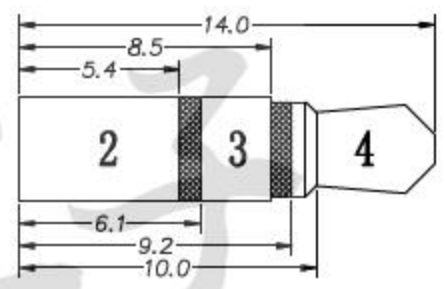
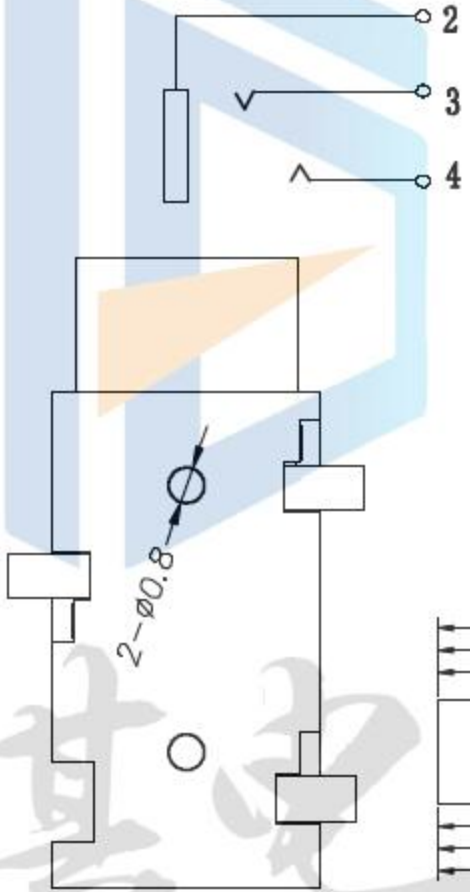
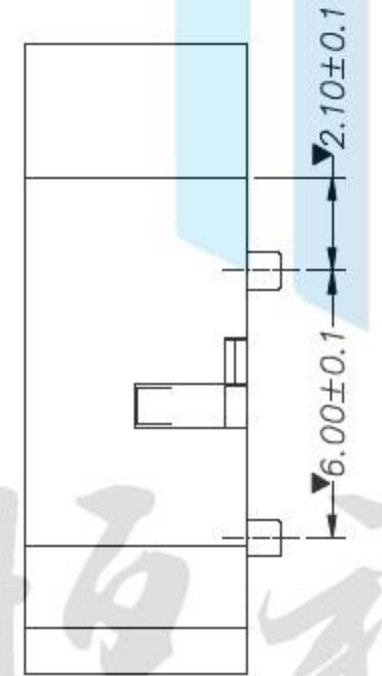
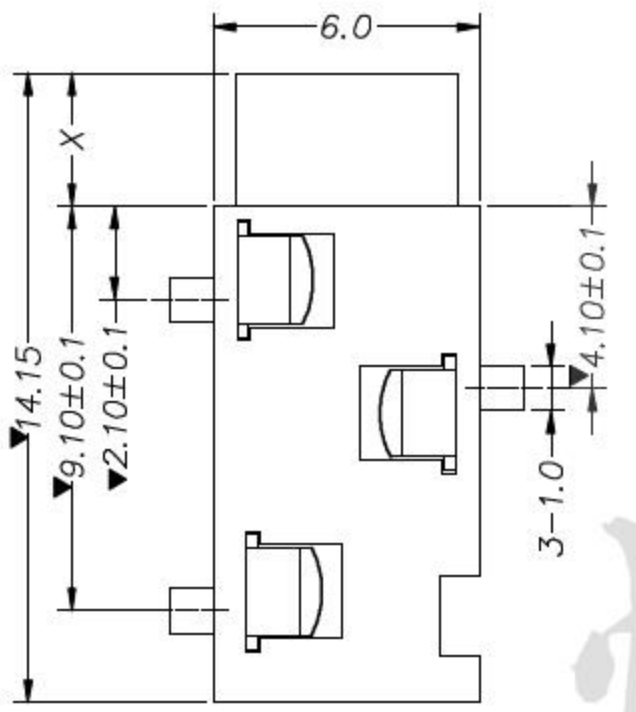

主要技术性能

额定电负荷	DC 30V\0.5A
接触电阻	≤0.03 Ω
绝缘电阻	≥100MΩ
耐压	AC500V(50Hz)/min
插拔力	3-20N
使用温度范围	-30-70℃
使用寿命	5000次

设计:	Arvin: 2016.03.08	范围 Range	公差 Tolerance
审核:	Arvin:	X.X ±	X.X ±0.30
校对:	Ru yi:	X.XX ±	X.XX ±0.20
比例:	视角关系:	X.XXX ±	X.XXX ±0.10
版次:	图框大小: A4	Angle ±	Angle ±5°

东莞市恒祺电子科技有限公司

名称: 耳机插座 型号: PJ-320B

料号:
共 张 , 第 张 备注: